



Edition : 1.0
Date: (10/25)

Instruction Manual

INDUSTRIAL BACKING PANELS IBP-12, IBP-ST, IBP-22

Order Code: (A416, A426, A4265)

Before assembling, please pay attention to the following points in priority:

1. Confirm the names and quantity of the components.
2. Assemble it on the soft floor such as smooth carpet and flannel blanket.
3. Suggest wearing gloves to ensure that it can be assembled safely, and be certain that it will be done by more than two persons.
4. Tighten all screws before use.
5. Do not use it on an inclined or uneven surface.

1 Ceiling Panel

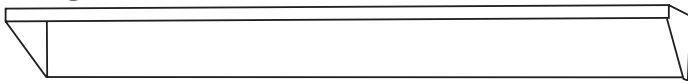

2 Backing Panel - Square Holes

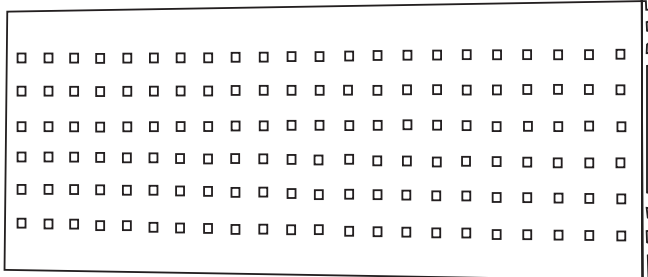

3 Backing Panel - Louvre Slots

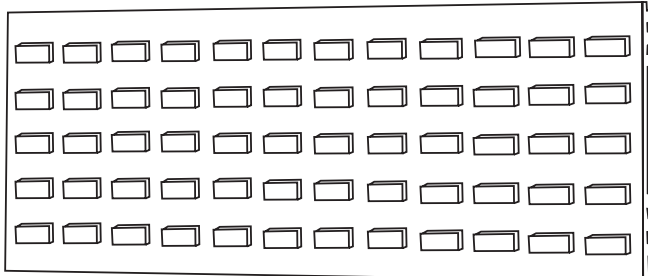

4 Holding Shelf

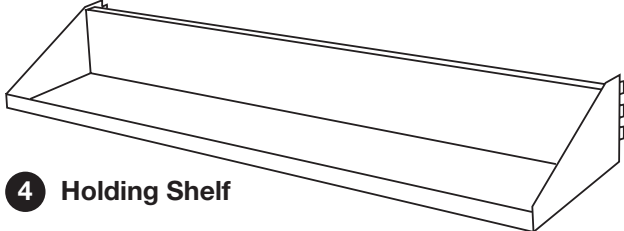

6 Screws



7 Clamp Pads



8 Plastic Knobs



5 Vertical Support

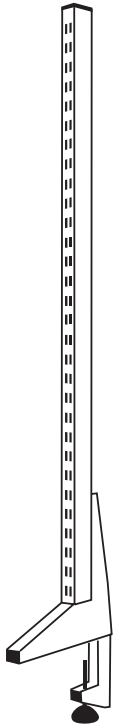

Model	1	2	3	4	5	6	7	8
IBP-12	1	1	1	1	2	4	2	2
IBP-ST	1	2	2	1	3	6	3	3
IBP-22	1	2	2	1	3	6	3	3

STEP 1

Assemble the Vertical Supports (5) with supplied Screws (6) & Plastic Knobs (8)

5 Vertical Support

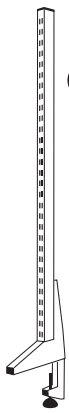

5 Vertical Support



6 Screws



8 Plastic Knob

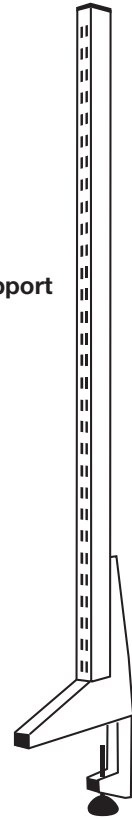

STEP 2

Install all the vertical supports (5) to your work bench and secure loosely by tightening the plastic knob (8) while placing the Clamp Pad (7) between the work bench and Plastic Knob Screw (8) as shown in (Fig. 1).

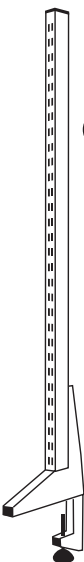

5 Vertical Support

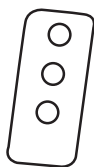

7 Clamp Pad

(Fig. 1)

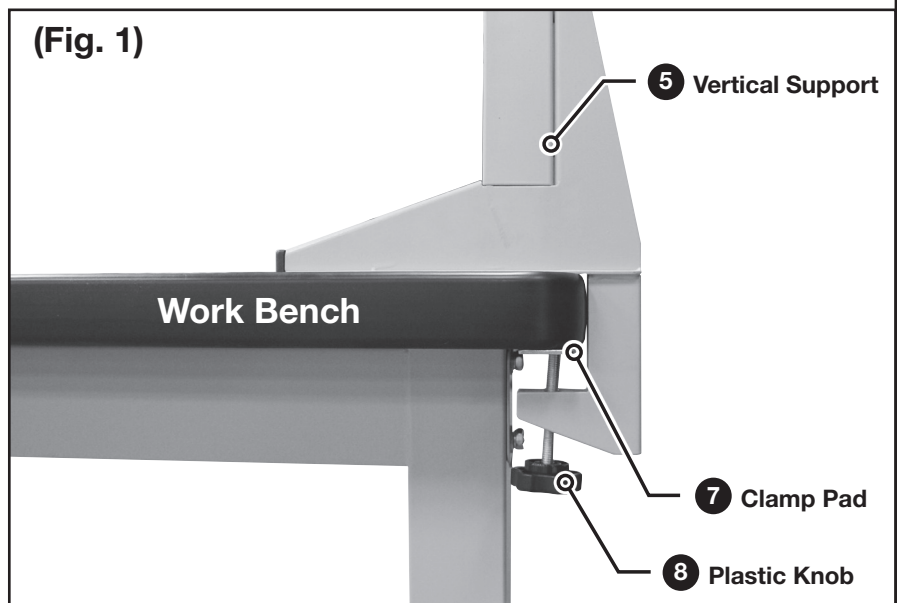

5 Vertical Support

Work Bench

7 Clamp Pad

8 Plastic Knob

STEP 3

Attach the Lower Holding Shelf (4) into the outside slots of the Vertical Supports (5), You may need to loosen and re-position the Vertical Supports (5) to align with the Holding Shelf (4) as shown in (Fig. 2).

Make sure to tighten Plastic Knobs (8) once in place.

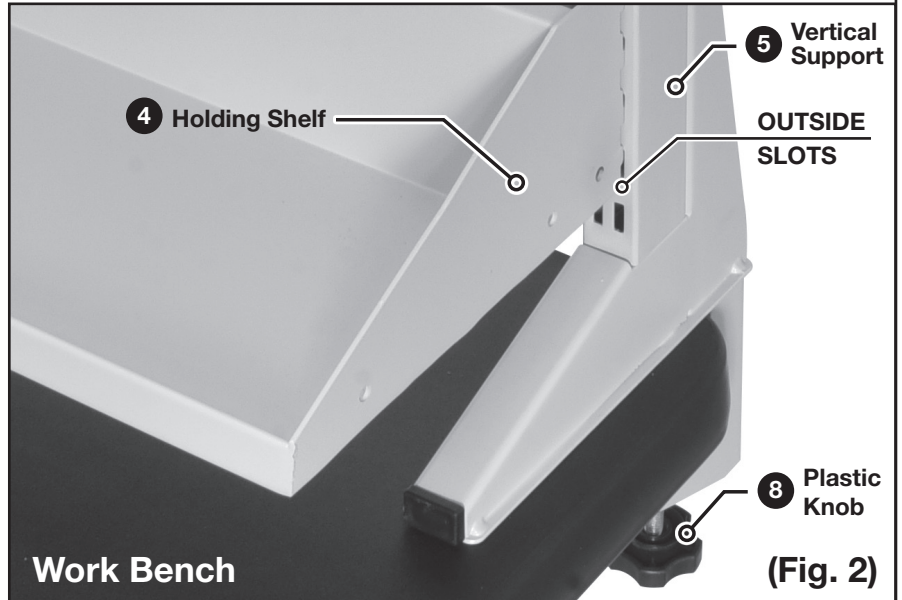
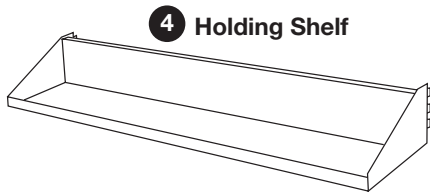

STEP 4

Attach your choice of Backing Panel (2 or 3) into the inside slots of the Vertical Supports (5) as shown in (Fig. 3).

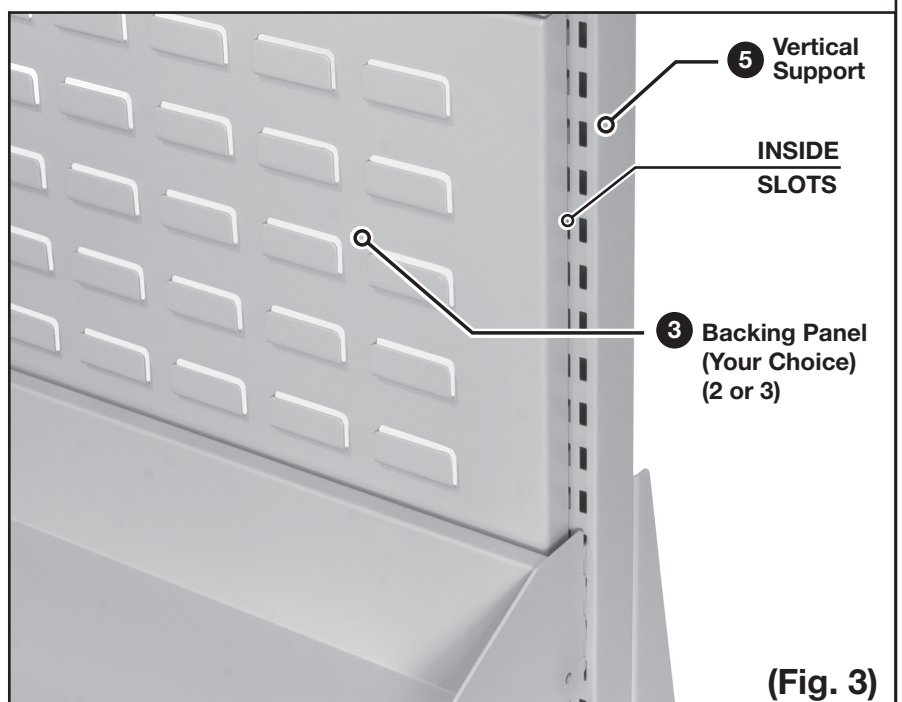
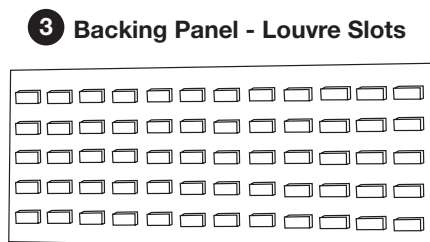
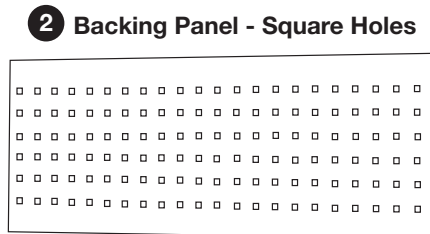

STEP 5

Attach your choice of Backing Panel (2 or 3) into the inside slots of the Vertical Supports (5) as shown in (Fig. 4).

2 Backing Panel - Square Holes

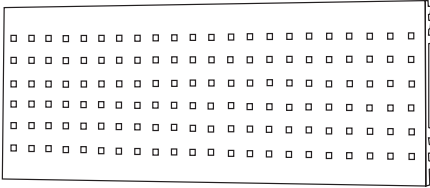

3 Backing Panel - Louvre Slots

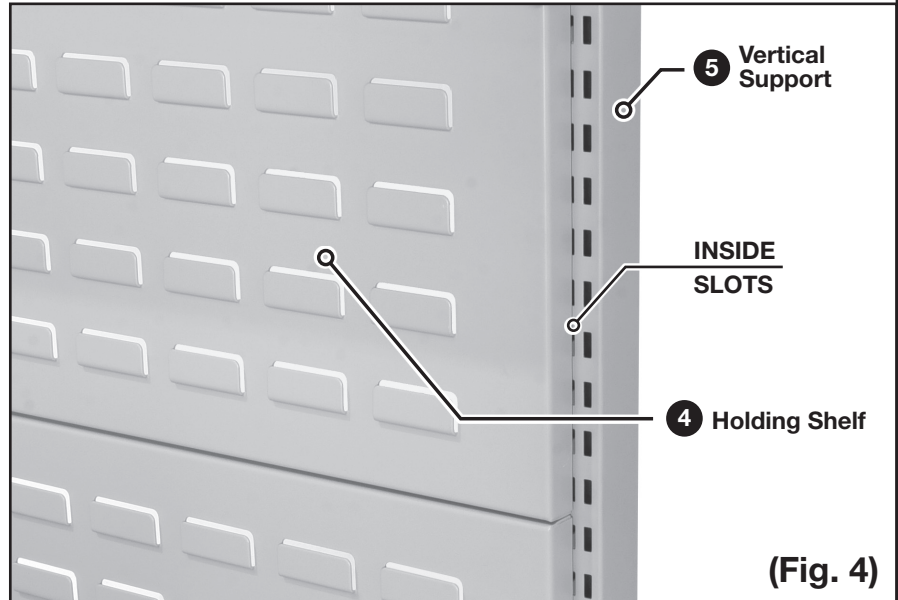
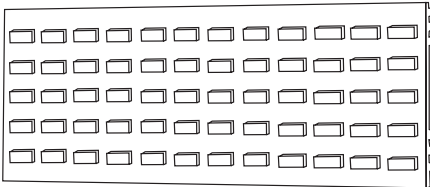

STEP 6

Attach the Ceiling Panel (1) into the outside slots of the Vertical Supports (5) as shown in (Fig. 5).

1 Ceiling Panel

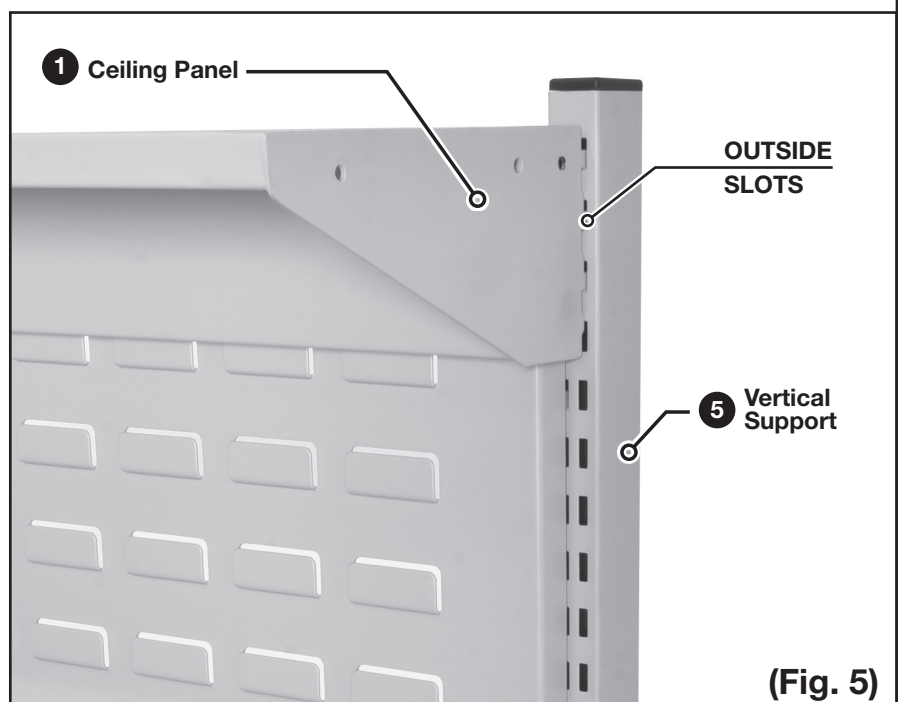



ENVIRONMENT PROTECTION

Recycle unwanted materials instead of disposing of them as waste. All tools, accessories and packaging should be sorted, taken to a recycling centre and disposed of in a manner which is compatible with the environment. When the product becomes completely unserviceable and requires disposal, drain any fluids (if applicable) into approved containers and dispose of the product and fluids according to local regulations.

Imported by



Australian Distributor

**Hare & Forbes
Machineryhouse**
Sydney - Melbourne
Adelaide - Brisbane - Perth

Ph: 1300 202 200
www.machineryhouse.com.au



New Zealand Distributor

Machineryhouse
Auckland
Christchurch

Ph: 0800 142 326
www.machineryhouse.co.nz